



TERMA

SINCE 1990

Angus Vertical

RAL 4009 // 1460 — 520 // 50 mm connection valve + “Noble” thermostatic head

MODERN



DESIGN: Artes Design

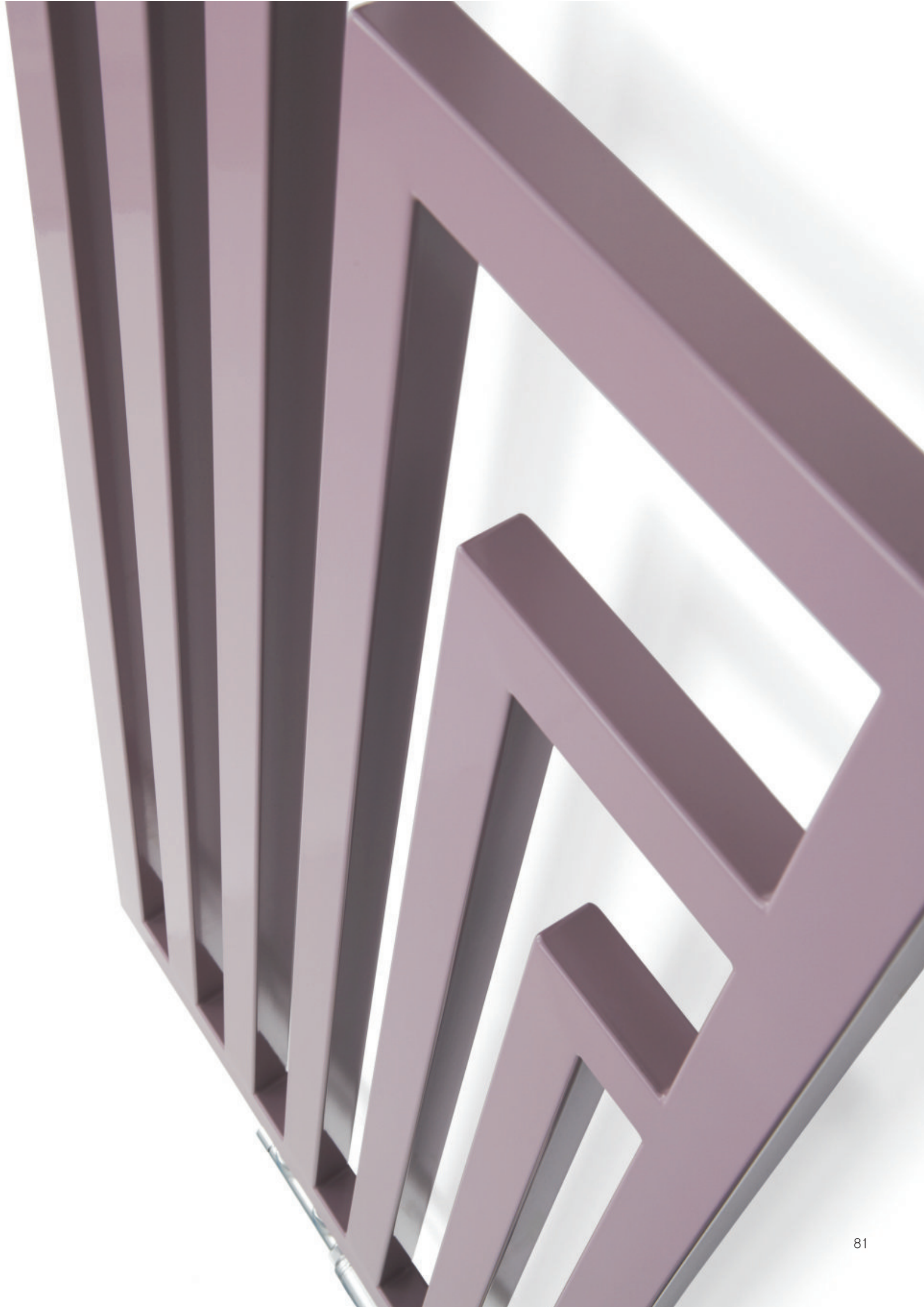

Vertical



Standard connections:

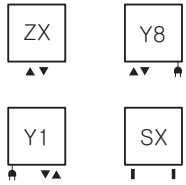

Sizes available:

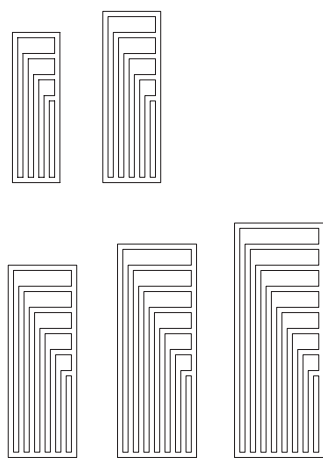

Division wall



Standard connections:

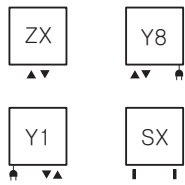

Sizes available:

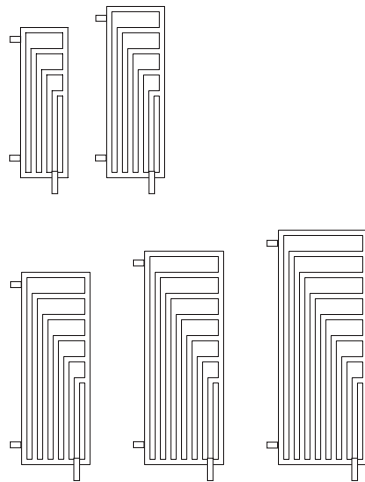

Horizontal



Standard connections:

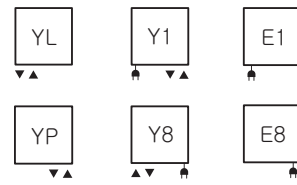

Sizes available:

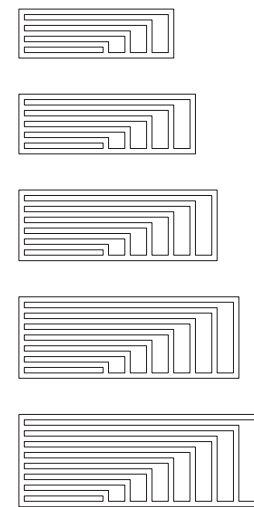

A	B	C	C'	$\frac{75^\circ}{65^\circ}$ $\frac{20^\circ}{20^\circ}$	$\frac{55^\circ}{45^\circ}$ $\frac{20^\circ}{20^\circ}$		D	E	F		
[mm]	[mm]	[mm]	[mm]	[W]	[W]	[W]	[mm]	[mm]	[mm]	[dm³]	[Kg]
Vertical											
1140	360	50	320	421	215	400	320	960	90	5,2	11,20
1300	440	50	400	557	284	600	400	1120	90	6,9	14,96
1460	520	50	480	711	363	800	480	1280	90	8,9	19,20
1620	600	50	560	905	462	1000	560	1440	90	11,1	23,93
1780	680	50	640	1116	569	1200	640	1600	90	13,5	29,14
DW											
1140	360	50	320	421	215	400	-	160	100	5,2	11,20
1300	440	50	400	557	284	600	-	240	100	6,9	14,96
1460	520	50	480	711	363	800	-	320	100	8,9	19,20
1620	600	50	560	905	462	1000	-	400	100	11,1	23,93
1780	680	50	640	1116	569	1200	-	480	100	13,5	29,14
Horizontal											
360	1140	50	-	411	210	400	1100	160	100	5,2	11,2
440	1300	50	-	549	280	400	1260	240	100	6,9	14,96
520	1460	50	-	705	360	600	1420	320	100	8,9	19,2
600	1620	50	-	878	448	800	1580	400	100	11,1	23,9
680	1780	50	-	1069	545	1000	1740	480	100	13,5	29,1

Vertical

ZX

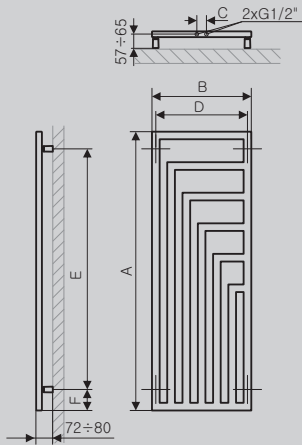

Division wall

ZX

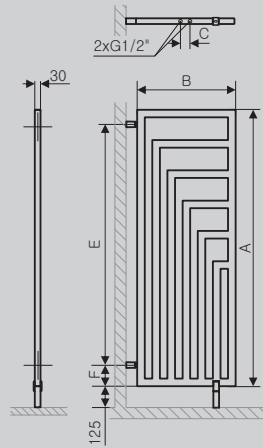

Horizontal

YL

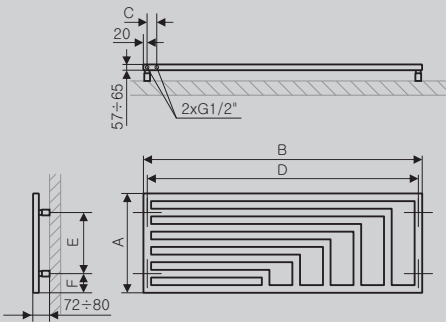

Profile

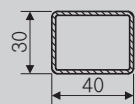

Y8

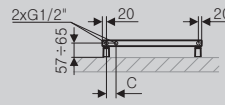

Y1

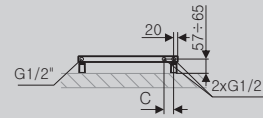

SX

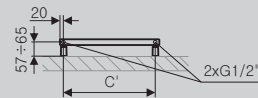

Y8

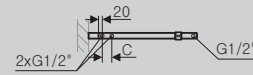

Y1

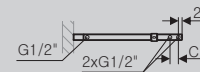

SX

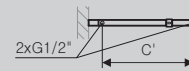

YP

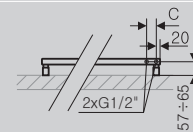

Y1

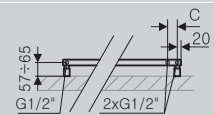

Y8

